



2021-2022 Ram TRX
Nylon Mud Flap Set, 1.5" Offset, Front
Mounting Diagram & Instructions
Kit# GCN39F

IMPORTANT:

Manufacturer is not responsible for negligent use of vehicle with mud flaps installed, including over-tightening of screws and bolts causing damage to vehicle or mud flaps.



TOOLS REQUIRED-

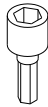

1/4" Socket Driver

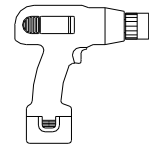

Electric or Rechargeable Drill

FLAPS

*(1) Flap Assy Upper Rear, DS
Part #770185*

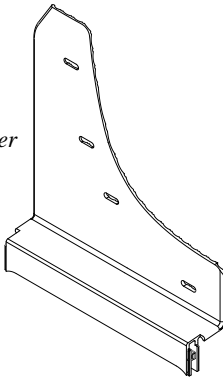

*(1) Flap Assy Upper Rear, PS
Part #770186*

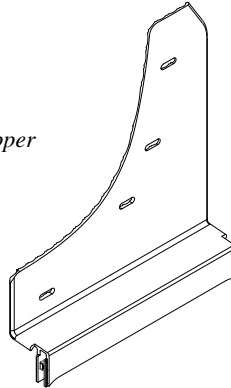

*(2) Rubber Flap Universal
12" x 8-3/4"*

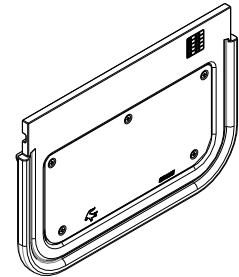

Please note: There will be a plastic piece in the upper mount channel. Please remove and discard.

*(2) Nylon Cap
Driver Side
Part #080642
(Assembled on Upper Mount)*

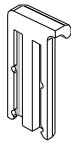

*(2) Nylon Cap
Passenger Side
Part #080643
(Assembled on Upper Mount)*

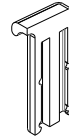

PARTS BAG # 770183

*a) (8) Washer, Offset
0.203" x 1.5", 18g, SS, Blk. Oxid.
Part #018080*

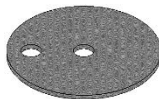

*b) (8) Washer, Nylon, Black
0.203" x 0.885" x 0.062" Thick
Part #054080*

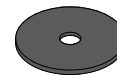

ASSEMBLY OF NYLON MUD FLAPS:

1. Remove locking caps from nylon upper mounts and set aside for reinstallation.
2. Remove and discard the plastic strip inside the track at the bottom of the nylon upper mount. (See Diagram #1).
3. Slide rubber guide into track of nylon upper mount.
4. Reinstall locking cap(s) on bottom of nylon upper mount. Note: To fully lock this cap into place, you should hear two clicks. When the cap is fully locked, it will be even with the offset part of the upper mount. (See Diagram #1).
5. Repeat Procedure for second mud flap.

MUD FLAPS:

1. Before you install your Mud Flap Set, see the diagram and parts list for all necessary parts. Start on the driver's side.
2. Remove the four factory screws from wheel well holes #5 to #8. Set aside for reinstallation.
3. Loosely install mud flap holes #1 to #4 to factory holes #5 to #8 using the factory screw, provided nylon washer (b) and offset washer (a).
4. Using a bubble level or other levelling tool, ensure that the mud flap is level. Tighten all fasteners.
5. Repeat procedure for passenger side.

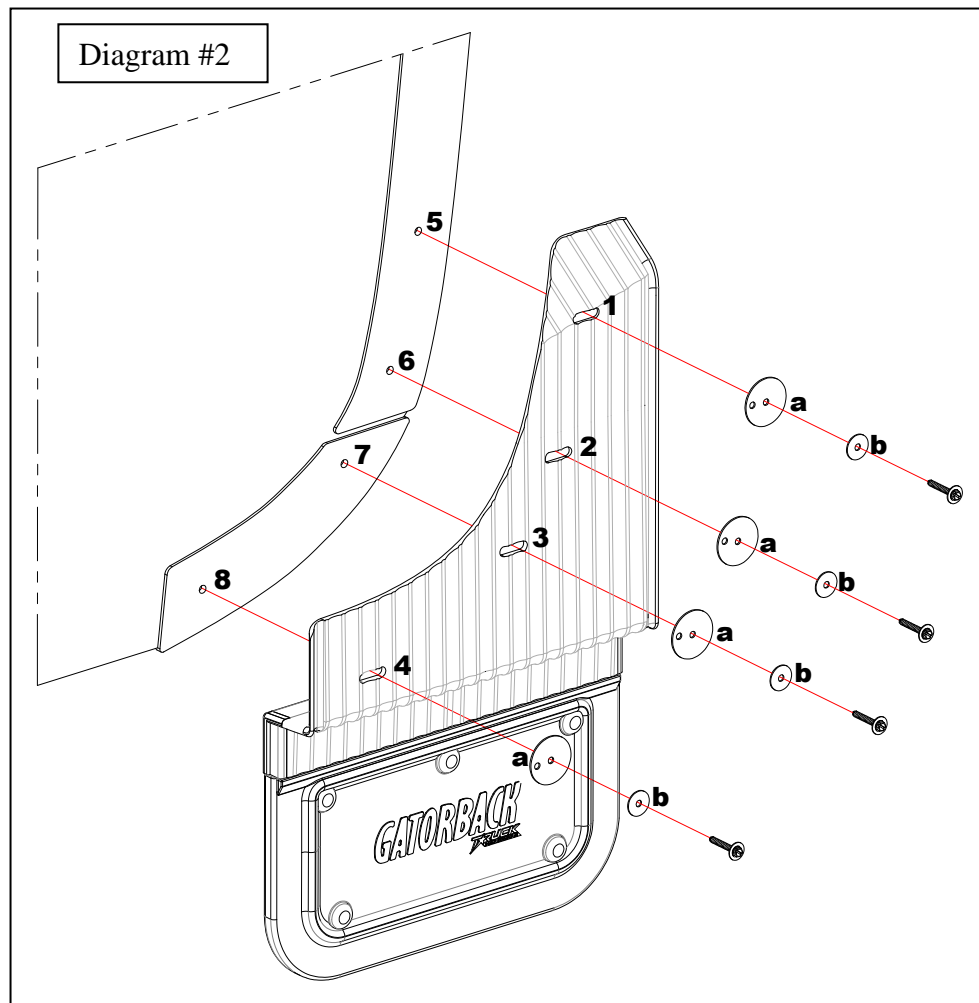
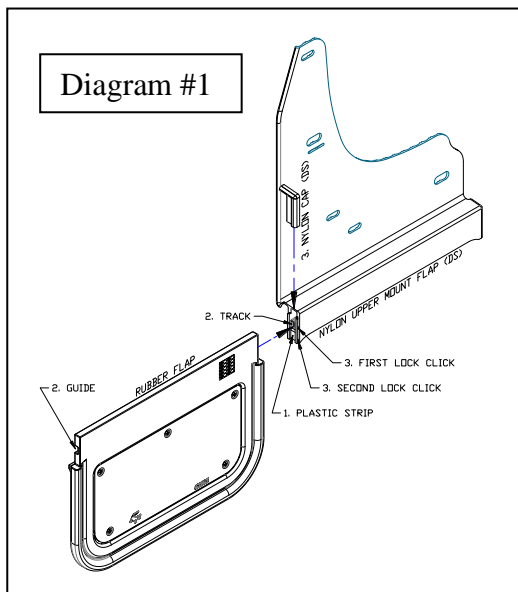

Please check out our YouTube channel to see an install video for this application.



IMPORTANT:

Manufacturer is not responsible for negligent use of vehicle with mud flaps installed, including over-tightening of screws and bolts causing damage to vehicle or mud flaps.

TOOLS REQUIRED-

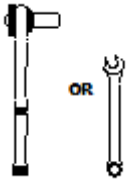

7/16" Open Wrench or
Socket Wrench

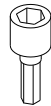

1/4" Socket Driver



1/4" Drill
Bit

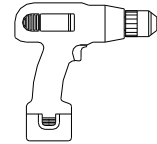

Electric or Rechargeable
Drill

FLAPS

(1) Flap Assy Upper
Rear, DS
Part #770187

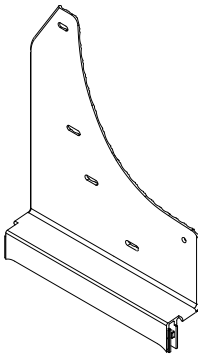

(1) Flap Assy Upper
Rear, PS
Part #770188

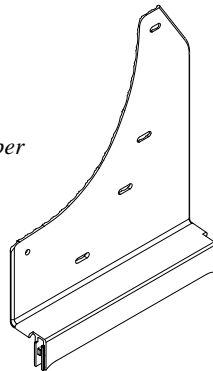

(2) Rubber Flap
Universal
12" x 10-3/4"

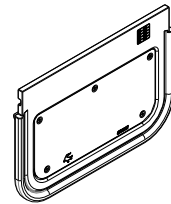

Please note: There will be a plastic piece in the upper mount channel. Please remove and discard.

(2) Nylon Cap
Driver Side
Part #080642
(Assembled on Upper Mount)

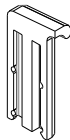

(2) Nylon Cap
Passenger Side
Part #080643
(Assembled on Upper Mount)

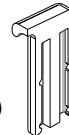

PARTS BAG # 770184

a) (6) Washer, Offset
0.203" x 1.5", 18g, SS, Blk. Oxid.
Part #018080

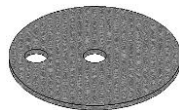

b) (6) Washer, Nylon, Black
0.203" x 0.885" x 0.062" Thick
Part #054080



c) (4) Washer, Flat
0.203" x 1", 18g SS, Blk Oxid.
Part #018070



d) (2) Capscrew, SS
1/4"-20 x 1" Blk. Oxid
Part #014073



e) (2) Washer, Lock
18-8 SS, 10.
Part #024001



f) (2) Hex Nut
#10-24, SS
Part #025003



ASSEMBLY OF NYLON MUD FLAPS:

1. Remove and discard the plastic strip inside the track at the bottom of the nylon upper mount. (See Diagram #1).
2. Slide rubber guide into track of nylon upper mount.
3. Install included cap(s) on bottom of nylon upper mount. To fully lock this cap into place, you should hear two clicks, and cap will be even with the offset part of the upper mount. (See Diagram #1).
4. Repeat Procedure for second mud flap.

MUD FLAPS:

2. Before you install your Mud Flap Set, see the diagram and parts list for all necessary parts. Start on the driver's side.
2. Remove the four factory screws from wheel well holes #6 to #9. Set aside for reinstallation.
3. Loosely install mud flap holes #2 to #4 to factory holes #7 to #9 using the factory screw, provided nylon washer (b) and offset washer (a).
4. Loosely install mud flap hole #1 to factory hole #6 using the factory screw.
5. Using a bubble level or other levelling tool, ensure that the mud flap is level. Tighten all fasteners.
6. Drill a 1/4" hole through mud flap hole #5 into factory plastic liner.
7. Install mud flap hole #5 to newly drilled hole using a cap screw (d) and flat washer (c) and secure using a flat Washer (c), lock washer (e), and hex nut (f).
5. Repeat procedure for passenger side.

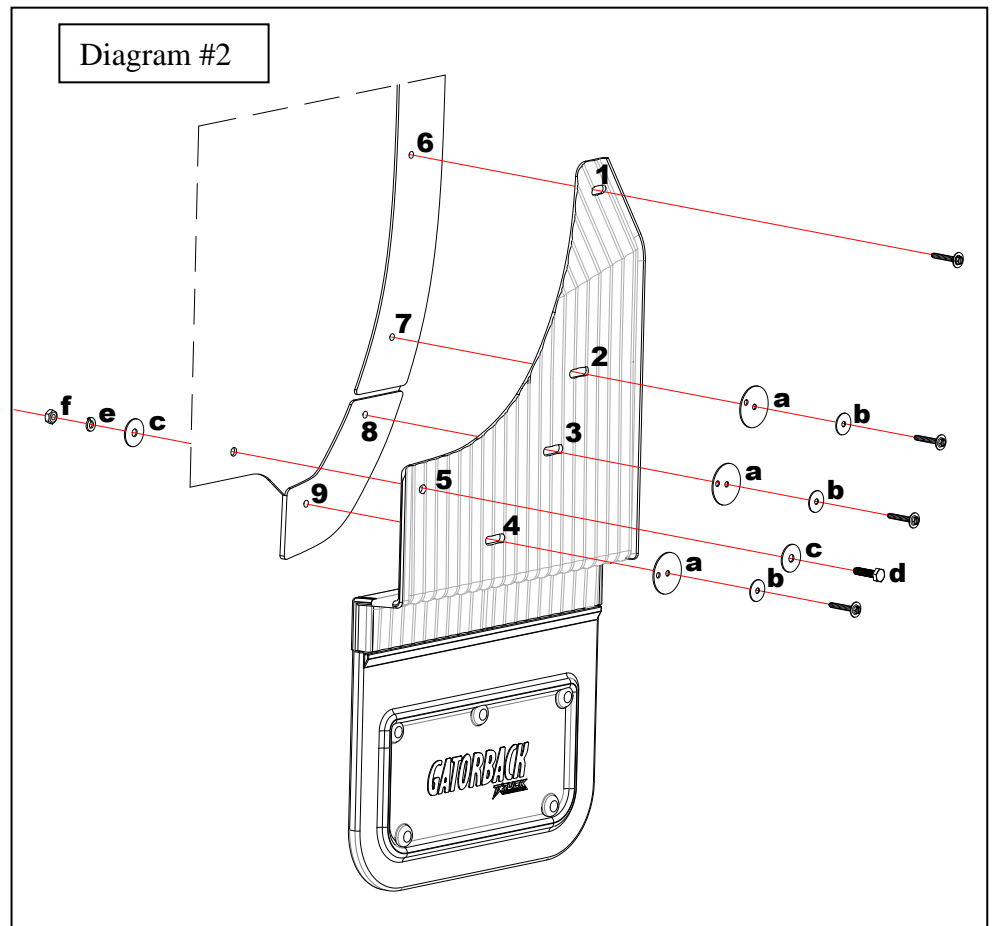
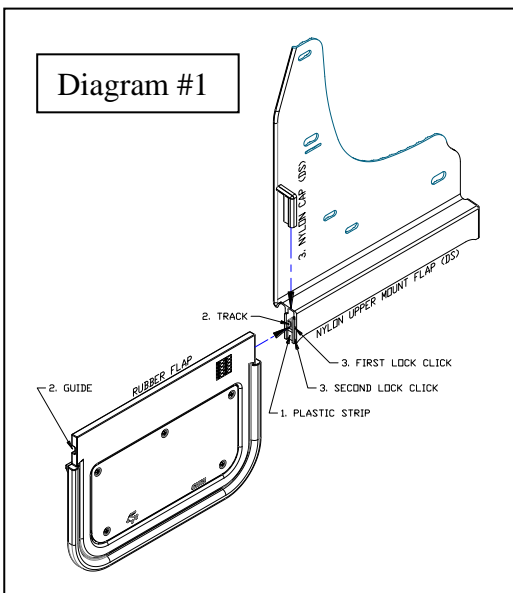

Please check out our YouTube channel to see an install video for this application.

