



TRUCK AND VAN EQUIPMENT

REPLACEMENT PARTS

POWDER COATED ALUMINUM RACK

MODELS 218 & 222

WWW.WEATHERGUARD.COM

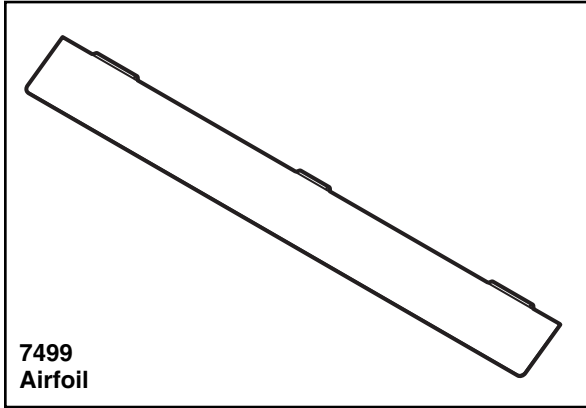

**7499
Airfoil**

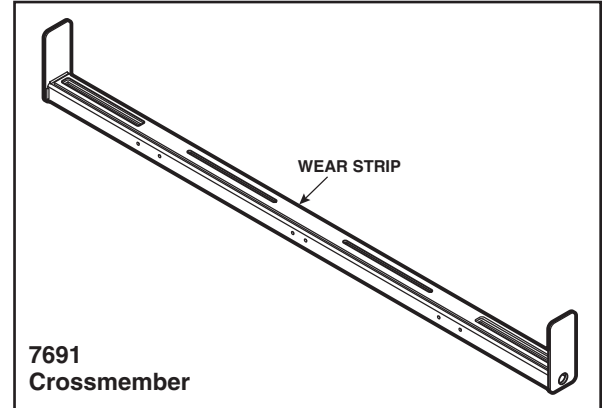

**7691
Crossmember**

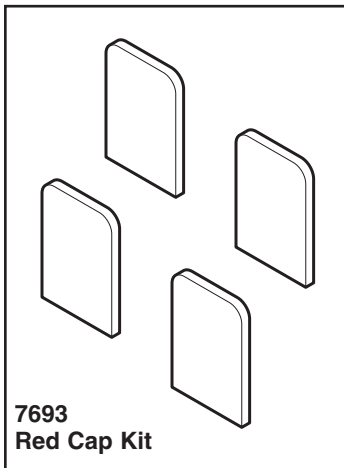

**7693
Red Cap Kit**

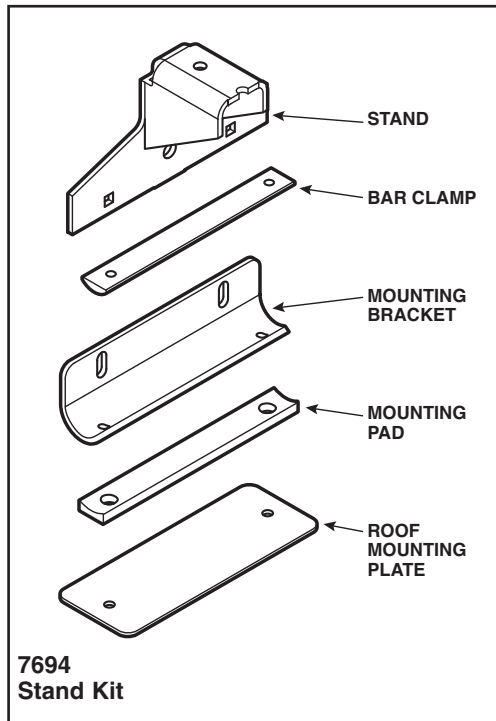



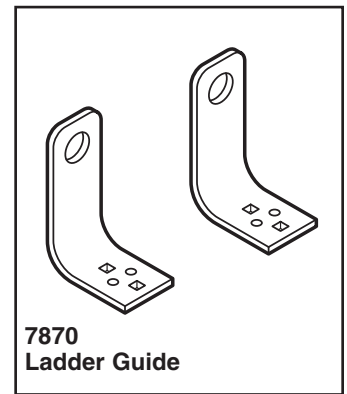



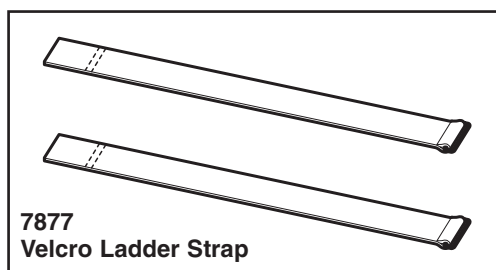





**7694
Stand Kit**

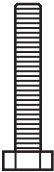

**7870
Ladder Guide**

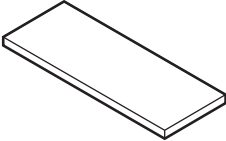

**7877
Velcro Ladder Strap**

				
Sealant	5/16-18 Stainless Steel Lock Nut	1/4-20 Stainless Steel Lock Nut	.344" x .75" Stainless Steel Washer	1/4" Stainless Steel Flat Washer
(1)	(16)	(8)	(32)	(1)
				
1/4" Stainless Steel Lock Washer	1/4-20 x 1-1/2" Stainless Steel Hex Head Bolt	14-20 x 2-1/4" Hex Head Bolt	5/16-18 x 7/8" Stainless Steel Carriage Bolt	
(4)	(8)	(1)	(16)	
				
8" x 2-5/8" x 1/4" Mounting Pad	Blind Fastener Install Tool	1/4-20 Blind Fastener	Spacer	
(4)	(1)	(4)	(8)	
				7692 218 Family Bolt Kit

MODEL	DESCRIPTION	QUANTITY	MODEL
7499	Airfoil	1	7499
7691	Crossmember	1	7691
7692	Bolt Kit	Kit	7692
7693	Red Cap Kit	Kit	7693
7694	Stand Kit	Kit	7694
7870	Ladder Guide	2	7870
7877	Velcro Ladder Strap	2	7877
24-0161	Instruction Manual	1	24-0161

Call Toll Free 1-800-456-7865, Fax Toll Free 1-800-334-2981



**KNAACK
MANUFACTURING CO.**
420 E. Terra Cotta Ave, Crystal Lake, IL 60014
815 459-6020, Fax 815 459-9097

©2005 Knaack Manufacturing Company

Rev A 5/05 Part No. 78-1504